



SYSTEM OF FLUID POWER

NEEDLE VALVES

IN-12

HYDRAULIC DIAGRAM

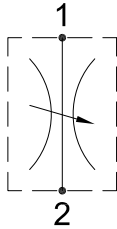

Type	Qnom (L/min)	Pmax (Bar)
IN-12	60	350

RATING DIAGRAM

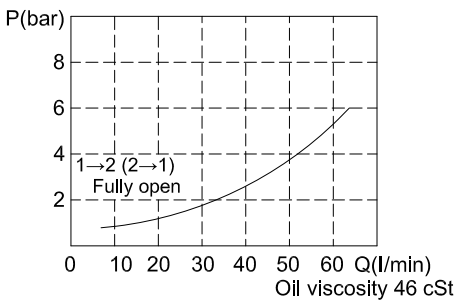

DIMENSIONS (mm)

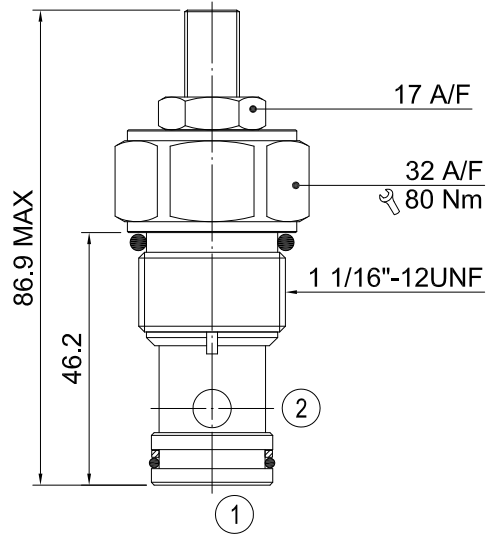

Cavities: see cavity data 12-02

CODE NUMBER

IN-12-L

Manual Adjustment

(See Line Body Ordering)
Omit for standard cartridge valves

■ APPLICATION

The cartridge needle valves can be set and locked to restrict flow in both directions. A typical use is the speed control of cylinders or other actuators. The flow's fine adjustment and complete shut-off allow the valves to be used for snubbing pressure gauges and for use as shut-off valves.

■ OPERATION

The poppet/adjuster can be screwed out to open the valve and set the level of throttling required in either flow direction, port 2 to port 1, or port 1 to port 2.

■ PERFORMANCE

Rated Flow : 60 l/min Max. pressure : 350 bar
Working temperature :
Min. -20°C, Max. 90°C, with standard BUNAN gaskets
Min. -20°C, Max. 120°C, with optional VITON gaskets on request

■ RECOMMENDATIONS

Fluid: best use mineral oil with viscosity ranging between 10 and 200 cSt
Filter: 25 micron or better
Cavities: see cavity data 12-02
Installation: before screwing the cartridge on the valve body, ascertain to provide suitable gasket lubrication with clean oil and also be sure to screw the cartridge manually in to reach against the gaskets in the valve body.

H B HYDRAULICS CO., LTD. reserves the variations and modifications of technical features and dimensions; and also reserves the right to stop production of each and any model listed in the catalogue with no notice.