

NEEDLE VALVES WITH REVERSE CHECK

INC-12R

HYDRAULIC DIAGRAM

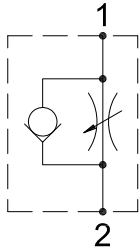

Type	Qnom (L/min)	Pmax (Bar)
INC-12R	60	350

RATING DIAGRAM

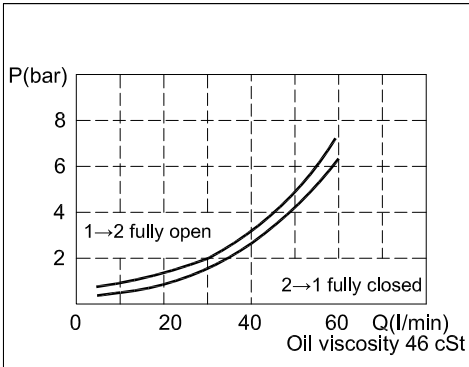

DIMENSIONS (mm)

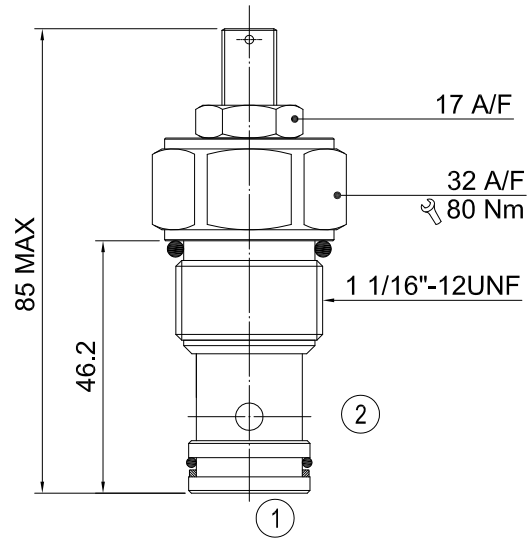

Cavities: see cavity data 12-02

CODE NUMBER

INC-12R-L

Manual Adjustment

(See Line Body Ordering)
Omit for standard
cartridge valves

■ APPLICATION

The cartridge needle valves can be set and locked to restrict flow in one direction. A typical use is the speed control of cylinders or other actuators. The flow's fine adjustment and control in one direction allow the valves to be used for regulating the inlet and outlet flow in one direction.

■ OPERATION

The poppet/adjuster can be screwed out to control the valve's opening portion and set the level of throttling required from port 1 to port 2. Free flow maintains from port 2 to port 1.

■ PERFORMANCE

Rated Flow: 60 l/min Max. pressure: 350 bar
Working temperature:
Min. -20°C, Max. 90°C, with standard BUNAN gaskets
Min. -20°C, Max. 120°C, with optional VITON gaskets on request

■ RECOMMENDATIONS

Fluid: best use mineral oil with viscosity ranging between 10 and 200 cSt
Filter: 25 micron or better
Cavities: see cavity data 12-02
Installation: before screwing the cartridge on the valve body, ascertain to provide suitable gasket lubrication with clean oil and also be sure to screw the cartridge manually in to reach against the gaskets in the valve body.

H B HYDRAULICS CO., LTD. reserves the variations and modifications of technical features and dimensions;
and also reserves the right to stop production of each and any model listed in the catalogue with no notice.