

ISS-08-04

HYDRAULIC DIAGRAM

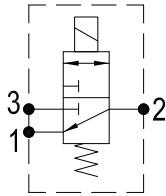

Type	Qnom (L/min)	Pmax (Bar)
ISS-08-04	12	210

RATING DIAGRAM

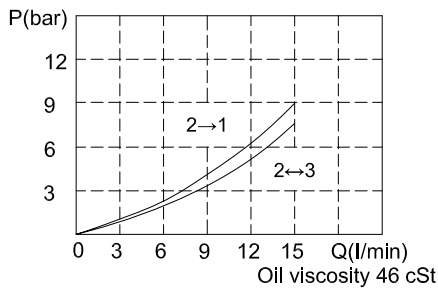

DIMENSIONS (mm)

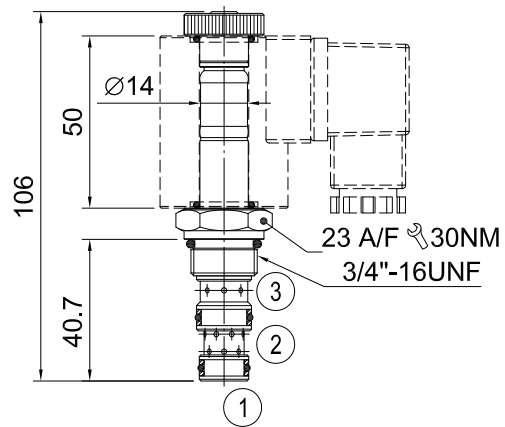

Cavities: see cavity data 08-03

CODE NUMBER

ISS-08-04-A1

Voltage Available

- 1) A1 = 110 VAC
- 2) A2 = 220 VAC
- 3) D1 = 12 VDC
- 4) D2 = 24 VDC

■ APPLICATION

The electric directional control valve, 3-way, 2-position direction control of flows. Typical usage includes the transmission device of the hydraulic system.

■ OPERATION

With the valve version and de-energized solenoid, the oil flow can be from port 1 to port 2, port 3 is closed. When the solenoid is energized, the flow is free from port 2 to port 3, port 1 is closed.

■ PERFORMANCE

Rated Flow: 12 l/min Max. pressure 210 bar
 Leakage : 40 ml/min at 210 bar and oil viscosity of 46 cSt
 Working temperature:
 Min. -20°C, Max. 90°C, with standard BUNAN gaskets
 Min. -20°C, Max. 120°C, with optional VITON gaskets on request

■ RECOMMENDATIONS

Fluid: best use mineral oil with viscosity ranging between 10 and 200 cSt
Filter: 25 micron or better
Cavities: see cavity data 08-03
Installation: before screwing the cartridge on the valve body, ascertain to provide suitable gasket lubrication with clean oil and also be sure to screw the cartridge manually in to reach against the gaskets in the valve body.

H B HYDRAULICS CO., LTD. reserves the variations and modifications of technical features and dimensions; and also reserves the right to stop production of each and any model listed in the catalogue with no notice.