

FLOW REGULATOR PRESSURE COMPENSATED VALVES

IF-12

HYDRAULIC DIAGRAM

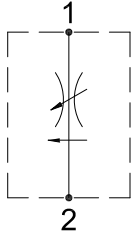

Type	Qnom (L/min)	Pmax (Bar)
IF-12	50	350

RATING DIAGRAM

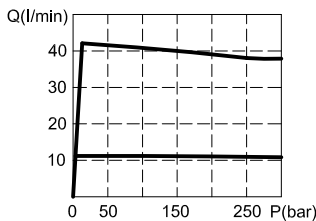

DIMENSIONS (mm)

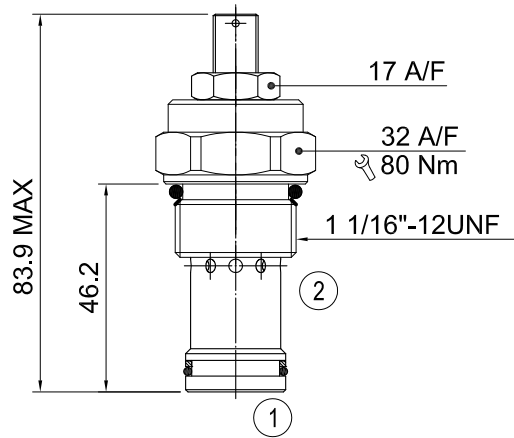

Cavities: see cavity data 12-02

CODE NUMBER

IF-12-L

Manual Adjustment

(See Line Body Ordering)
Omit for standard
cartridge valves

■ APPLICATION

The IF series are restrictive, pressure compensated flow regulator. It is used to restrict flow from a fixed supply. No matter how the unloading of cylinder changes, the valve can offer a fixed, regulated flow.

■ OPERATION

These valve are designed for adjustment of the oil flow from port 1 to port 2. The pressure drop across the orifice is sensed and produces a force which, at the required flow rate, overcomes the spring force. The resultant movement of the spool regulates the flow by closing the radial holes in the sleeve.

■ PERFORMANCE

Rated Flow: 50 l/min Max. pressure: 350 bar
Working temperature:
Min. -20°C, Max. 90°C, with standard BUNAN gaskets
Min. -20°C, Max. 120°C, with optional VITON gaskets on request

■ RECOMMENDATIONS

Fluid: best use mineral oil with viscosity ranging between 10 and 200 cSt
Filter: 25 micron or better
Cavities: see cavity data 12-02
Installation: before screwing the cartridge on the valve body, ascertain to provide suitable gasket lubrication with clean oil and also be sure to screw the cartridge manually in to reach against the gaskets in the valve body.

H B HYDRAULICS CO., LTD. reserves the variations and modifications of technical features and dimensions;
and also reserves the right to stop production of each and any model listed in the catalogue with no notice.