

CHECK VALVES

IC-10

HYDRAULIC DIAGRAM

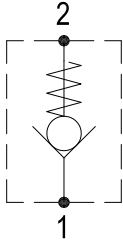

Type	Qnom (L/min)	Pmax (Bar)
IC-10	50	350

RATING DIAGRAM

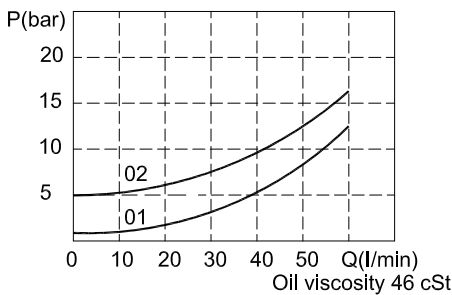

DIMENSIONS (mm)

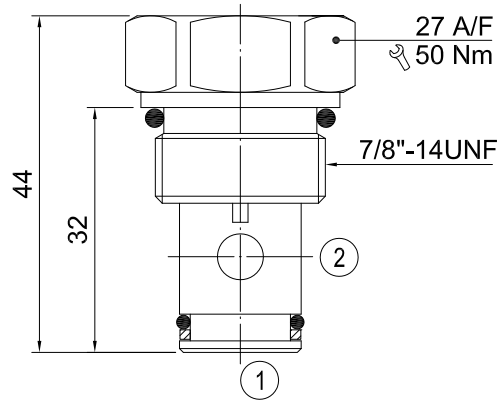

Cavities: see cavity data 10-02

CODE NUMBER

IC-10-01

Opening Pressure

- 1) 01 = 0.5 BAR
- 2) 02 = 5 BAR

■ APPLICATION

These cartridge check valves allow flow at a low pressure drop, with cracking pressure from 0.5 to 5 bar in the free flow direction and close to prevent flow in the reverse direction.

■ OPERATION

Oil flow is permitted from port 1 to port 2 and close to prevent flow in the reverse direction.

■ PERFORMANCE

Rated Flow : 50 l/min Max. pressure : 350 bar
 Opening pressure from port 1 to port 2: (1) 0.5 bar (2) 5 bar
 Leakage : 0.3 ml/min (5 dpm)
 Working temperature :
 Min. -20°C, Max. 90°C, with standard BUNAN gaskets
 Min. -20°C, Max. 120°C, with optional VITON gaskets on request

■ RECOMMENDATIONS

Fluid: best use mineral oil with viscosity ranging between 10 and 200 cSt
Filter: 25 micron or better
Cavities: see cavity data 10-02
Installation: before screwing the cartridge on the valve body, ascertain to provide suitable gasket lubrication with clean oil and also be sure to screw the cartridge manually in to reach against the gaskets in the valve body.

H B HYDRAULICS CO., LTD. reserves the variations and modifications of technical features and dimensions; and also reserves the right to stop production of each and any model listed in the catalogue with no notice.